

1000ml

Touch free automatic
dispenser system

SENSOR DISPENSER



Made in
HOLLAND

Battery Installation

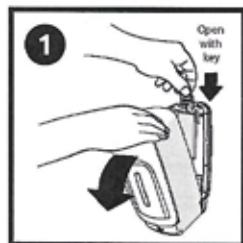

Use the dispenser key to open the front cover. Insert the key into the holes located at the top of the dispenser, push the key, and pull the cover towards you. The cover is hinged at the bottom of the dispenser.

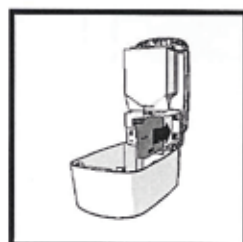

Take the battery compartment, located on the right side of the gearbox. Insert four AA-Litium batteries, making sure to place batteries in the compartment in the proper manner as shown in the diagram at the battery compartment. Replace the compartment and press until it clicks.

The dispenser will turn "on" automatically once batteries are installed. You see a long Blue light, signifying the compartment is activated properly.

*** If the dispenser appears non-functional, remove batteries, wait 1 minute and re-insert them.**

Dispenser Activation

- 1 To activate, place hand under bottom of the dispenser. If a second dose is needed, remove hand, and then replace hand under the dispenser or change settings dosing system.
- 2 The dispenser cover must be closed to activate.

Set up dosing system

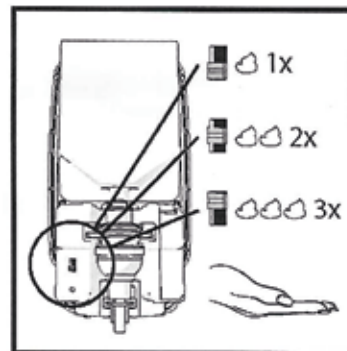

To set up dosing system use the black switch on the gearbox.

1. When switch is set to the lower position the red light will flash one time, the dispenser produces one shot each time.
2. When switch is set in the middle position the red light will flash two times, the dispenser produces two shots each time.
3. When switch is set to the upper position the red light will flash three times, the dispenser produces three shots each time.

Batteries

When the batteries are low a red light flashes once every second. The four AA-Litium batteries will last 25,000 hand washes or 3 years, whichever comes first.

Mounting the Dispenser

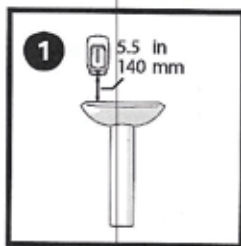

The dispenser should be mounted 140 mm (5.5 inches) above the counter-top, sink or any other surface.

- 2** Once the batteries have been installed, close dispenser cover.

The dispenser can be mounted to either a mirror or a tile surface using the double-sided tape provided (3) or tighten the dispenser to the wall (4).

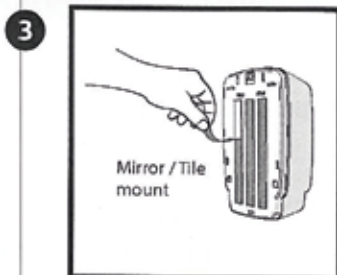

Use the alcohol wipe provided to thoroughly clean any surface when using the adhesive tape attached. When the surface is dry, pull off the protective backing off the adhesive tape and mount the dispenser to the wall holding it in place for 20-30 seconds allowing the tape to adhere to the mounting surface. Remove the batteries from the dispenser. Wait 24 hours before installing the batteries and refill in the dispenser.

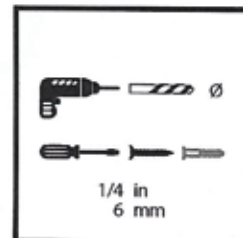
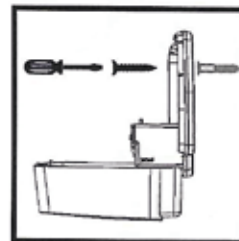
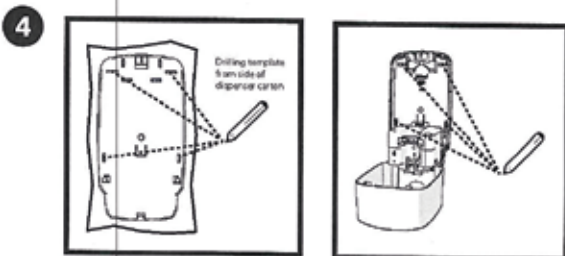

Using the drilling template from the dispenser carton. Drill holes into wall with a 6mm or "1/4" drill bit where dispenser is to be mounted. Remove template and align holes in backplate of the dispenser with the pre-drilled holes. Screws and anchors are included to mount the dispenser to the wall.

NOTE: Insure that proper mounting hardware is used for your particular wall composition

Refill insertion

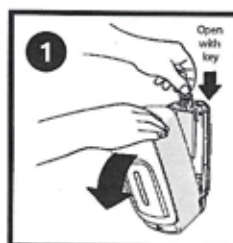

Open the dispenser cover with the dispenser key.

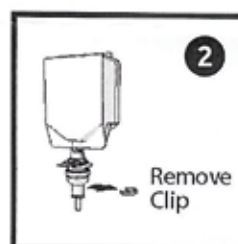

Take the refill pouch out of the box. Remove the red clip by sliding it sideways. Place the refill pouch with the nozzle pointing down into the dispenser

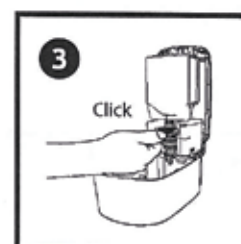
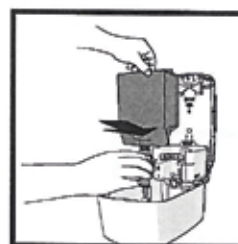

Fit the pouch connector into the U-shaped bracket insuring the nozzle fits into the actuator lever. Click.

- 4** Fit the refill pouch and make sure the dispenser lock system is free and close the cover
- 5** Three short blue flashes will show up, once the dispenser is properly installed.
- 6** Test for proper operation, by dispensing soap into your hand.